



T SERIES TEST BENCH

TECHNICAL DATA - DATI TECNICI

HIGH PRESSURE MODE <i>TEST ALTA PRESSIONE</i>	1500bar / 21750 Psi
PRESSURE CONTROL <i>CONTROLLO DELLA PRESSIONE</i>	Manual
TEST <i>PROCEDURA TEST</i>	Manual
TYPE OF DRIVE <i>TIPO DI AZIONAMENTO</i>	Pneumatic / Electric Intensifier
TESTING LIQUID <i>LIQUIDO DI COLLAUDO</i>	Water
N° MANIFOLDS <i>N° MASSELLI</i>	1
N° CONNECTIONS PER MANIFOLD <i>N° CONNESSIONI PER MASSELLO</i>	1x1/4" BSP Quick Connection
LIQUID FILLING <i>RIEMPIMENTO LIQUIDO</i>	Manual
FILLING FLOW <i>PORTATA RIEMPIMENTO</i>	4 Lt/Min.
LOW / HIGH PRESSURE PUMP FLOW <i>PORTATA POMPA BASSA/ALTA PRESSIONE</i>	4 Lt/Min. / 1,55 Lt/Min.
PRESSURE DISCHARGE <i>SCARICO PRESSIONE</i>	Manual
PRESSURE GAUGE <i>MANOMETRO</i>	Analogic
STANDARD VOLTAGE <i>VOLTAGGIO STANDARD</i>	400V 50Hz 3PH

DIMENSIONS (LxWxH)

Machine (mm)	2200x1000x1300
Machine (inch)	86.6x39.4x51.2
Packaged (mm)	2300x1100x1500
Packaged (inch)	90.6x43.3x59.1

WEIGHT

Machine (kg/lbs)	270/595
Packaged (kg/lbs)	335/739

* ACCORDING TO THE FITTING.

FEATURES

- Easy to test
- High Pressure
- Safety Testing
- Main Parts MADE IN GERMANY
- Safety Testing with Pressure Automatic Release
- Fatigue Pressue Testing Equipment upon request

OPTIONS

- High pressure & Low-pressure full range pressure testing
- Electrical Control Testing Button
- Enhanced Safety:Automatic zero testing pressure when door is open
- Alarm light
- Low pressure from 5 bar testing

CONTROL

Manual

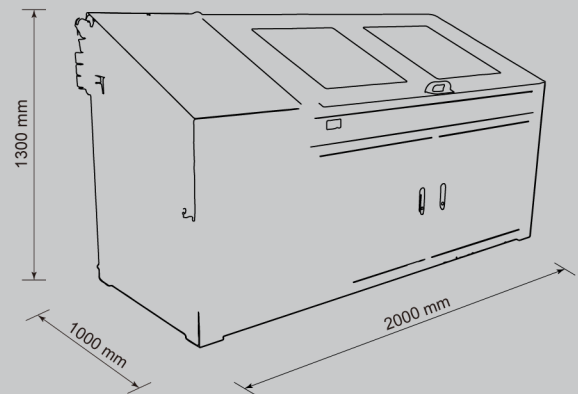

Products images & Specifications may alter prior official notice at any time.